

Swinghandles

Cut out

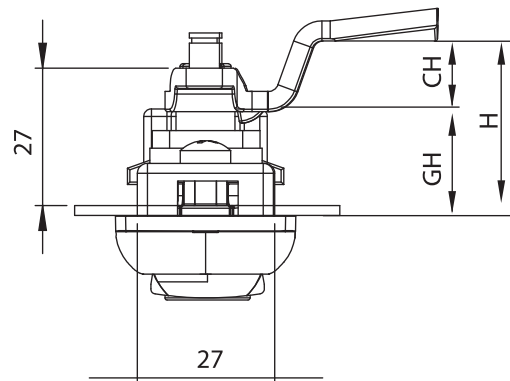

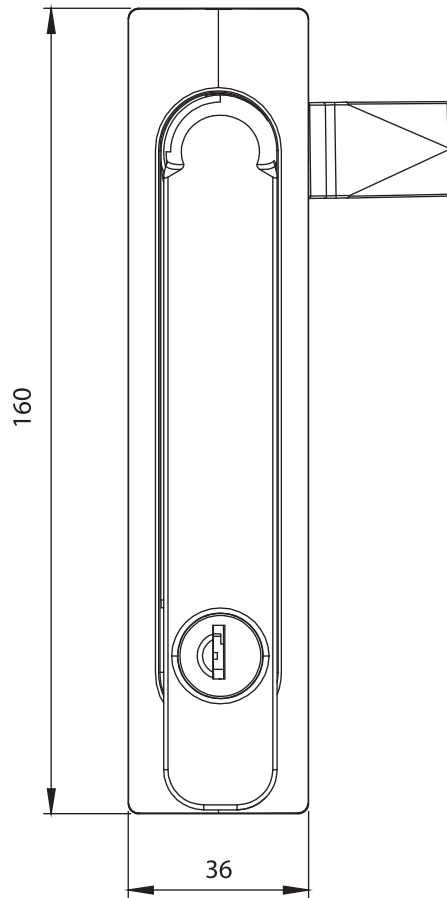
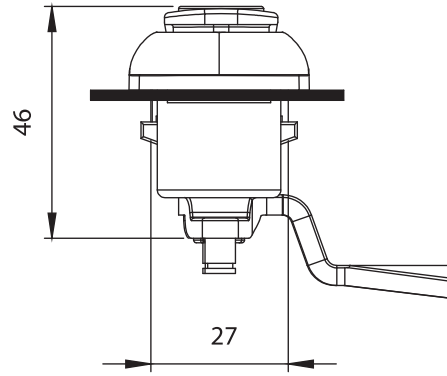
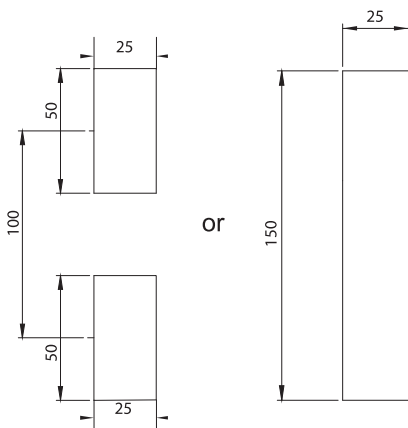
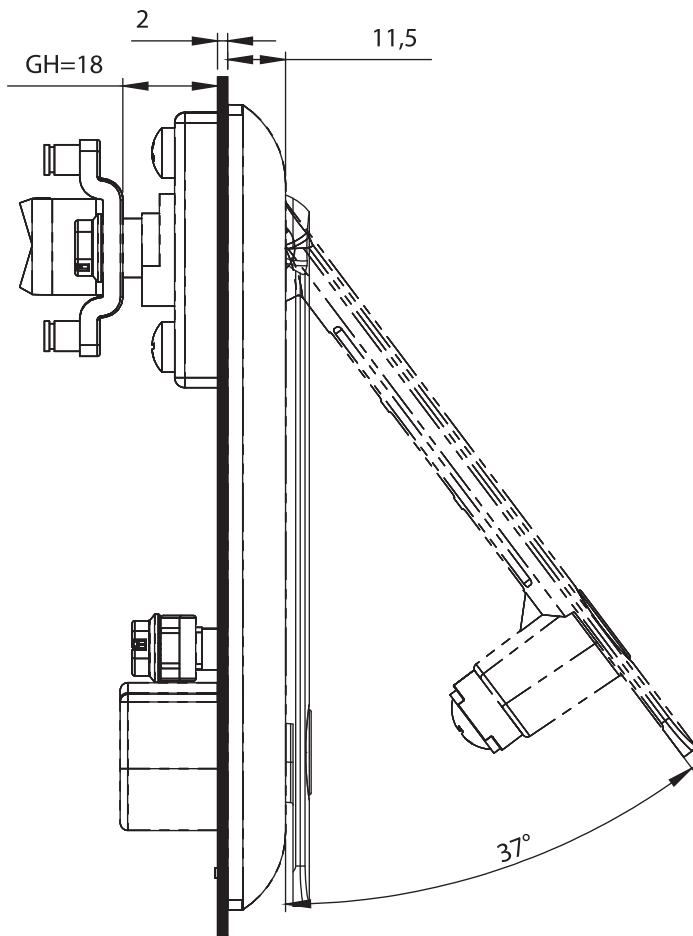

Swinghandles









Material

Handle : Zinc Die, black coated or chrome plated
Dish : Zinc Die, black coated or chrome plated
Padlock Device : Stainless Steel AISI 304

Options

Cams : Page 84-85
Round Rods : Page 81
Rod Guides : Page 82

2104 - Swinghandle (Zinc Die, black coated)

	Insert Types	Plain	Padlock Applicable
	Double Bit 3 mm	2104 - 041 - xxx	2104 - 341 - xxx
	Double Bit 5 mm	2104 - 042 - xxx	2104 - 342 - xxx
	Triangular 8 mm	2104 - 047 - xxx	2104 - 347 - xxx
	Triangular 8 mm	2104 - 043 - xxx	2104 - 343 - xxx
	Triangular 9 mm	2104 - 049 - xxx	2104 - 349 - xxx
	Square 7 mm	2104 - 044 - xxx	2104 - 344 - xxx
	Square 8 mm	2104 - 045 - xxx	2104 - 345 - xxx
	Slotted	2104 - 048 - xxx	2104 - 348 - xxx
	Keyed 3333	2104 - 023 - xxx	2104 - 323 - xxx
	Keyed Same	2104 - 027 - xxx	2104 - 327 - xxx
	Keyed Differ	2104 - 029 - xxx	2104 - 329 - xxx
	Keyed Differ with Master System	2104 - 028 - xxx	2104 - 328 - xxx

For chrome plated version, please use code 2124 instead of 2104.
 You may chose XXX section from cam tables.

Complete Metal

IP 65



LH/RH



RoHS