

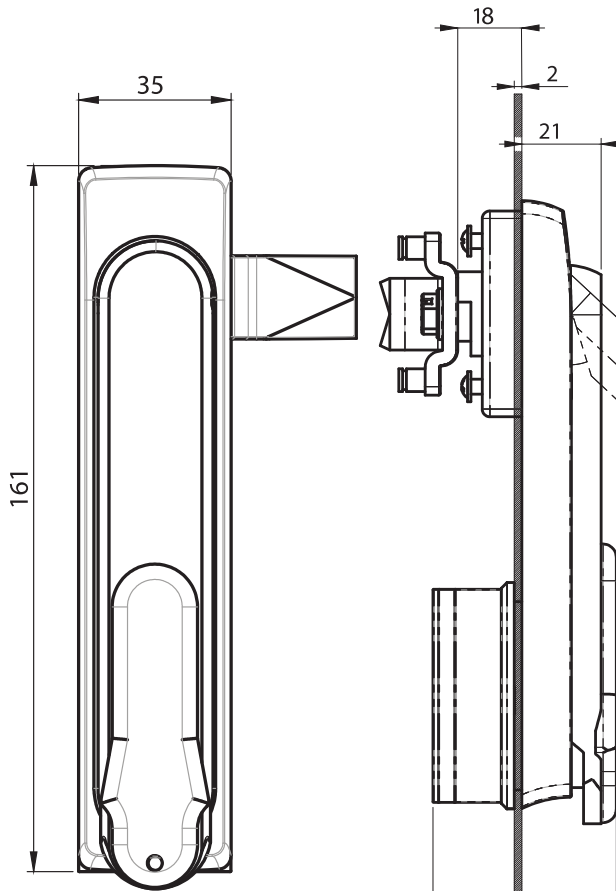

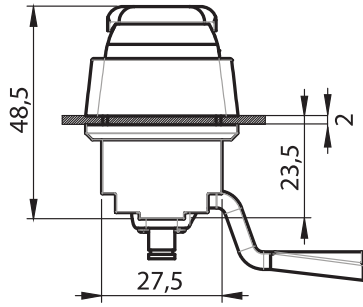

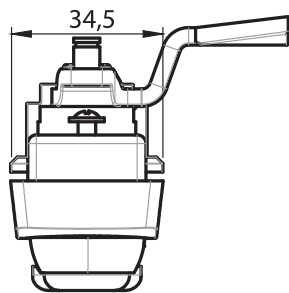

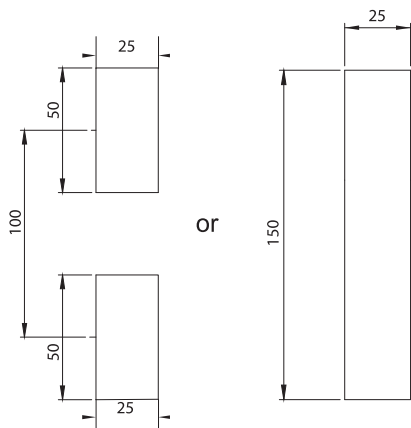



Swinghandles



Cut out











### 2205 - Swinghandle

WITHOUT PADLOCK		without Dustcover	with Dustcover
	Double Bit 3 mm	2205 - 041 - xxx	2205 - 141 - xxx
	Double Bit 5 mm	2205 - 042 - xxx	2205 - 142 - xxx
	Triangular 8 mm	2205 - 047 - xxx	2205 - 147 - xxx
	Triangular 8 mm	2205 - 043 - xxx	2205 - 143 - xxx
	Triangular 9 mm	2205 - 049 - xxx	2205 - 149 - xxx
	Square 7 mm	2205 - 044 - xxx	2205 - 144 - xxx
	Square 8 mm	2205 - 045 - xxx	2205 - 145 - xxx
	Slotted	2205 - 048 - xxx	2205 - 148 - xxx
	Keyed 3333	2205 - 023 - xxx	2205 - 123 - xxx
	Keyed Same	2205 - 027 - xxx	2205 - 127 - xxx
	Keyed Differ	2205 - 029 - xxx	2205 - 129 - xxx
	Keyed Differ with Master System	2205 - 028 - xxx	2205 - 128 - xxx

You may chose XXX section from cam tables

### 2205 - Swinghandle

WITH PADLOCK		without Dustcover	with Dustcover
	Double Bit 3 mm	2205 - 341 - xxx	2205 - 241 - xxx
	Double Bit 5 mm	2205 - 342 - xxx	2205 - 242 - xxx
	Triangular 8 mm	2205 - 347 - xxx	2205 - 247 - xxx
	Triangular 8 mm	2205 - 343 - xxx	2205 - 243 - xxx
	Triangular 9 mm	2205 - 349 - xxx	2205 - 249 - xxx
	Square 7 mm	2205 - 344 - xxx	2205 - 244 - xxx
	Square 8 mm	2205 - 345 - xxx	2205 - 245 - xxx
	Slotted	2205 - 348 - xxx	2205 - 248 - xxx
	Keyed 3333	2205 - 323 - xxx	2205 - 223 - xxx
	Keyed Same	2205 - 327 - xxx	2205 - 227 - xxx
	Keyed Differ	2205 - 329 - xxx	2205 - 229 - xxx
	Keyed Differ with Master System	2205 - 328 - xxx	2205 - 228 - xxx

You may chose XXX section from cam tables







Swinghandles

#### Material

- Handle** : Polyamide (PA6 GFR30), black
- Dish** : Polyamide (PA6 GFR30), black
- Dust Cover** : Polyamide (PA6 GFR30), black
- Padlock Device** : Stainless Steel, AISI 304

#### Options

- Cams** : Page 84-85
- Round Rods** : Page 81
- Rod Guides** : Page 82

 Complete Plastic	 IP 65	 LH/RH
		RoHS