

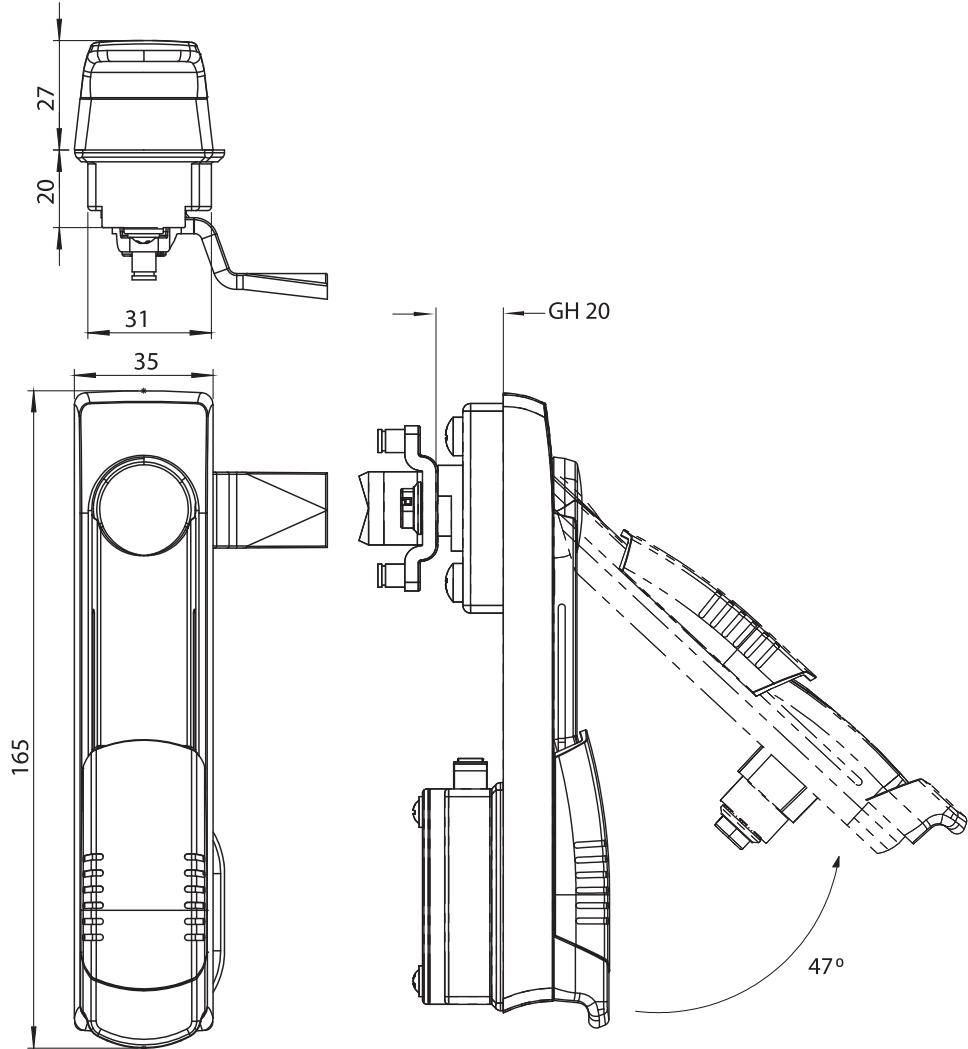

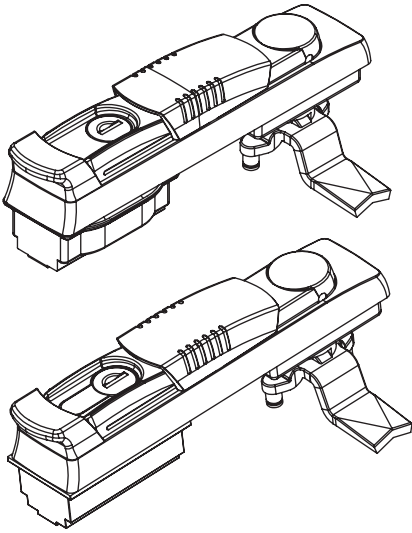

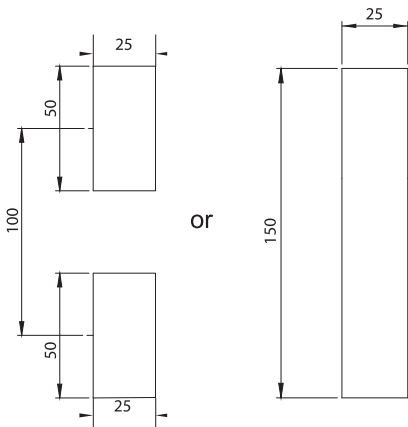



Swinghandles



Cut out











2206 - Swinghandle

Type of Cylinder		
	Double Bit 3 mm	2206 - 041 - xxx
	Double Bit 5 mm	2206 - 042 - xxx
	Triangular 8 mm	2206 - 047 - xxx
	Triangular 8 mm	2206 - 043 - xxx
	Triangular 9 mm	2206 - 049 - xxx
	Square 7 mm	2206 - 044 - xxx
	Square 8 mm	2206 - 045 - xxx
	Slotted	2206 - 048 - xxx

	Keyed 3333	2206 - 023 - xxx
	Keyed Same	2206 - 027 - xxx
	Keyed Differ	2206 - 029 - xxx
	Keyed Differ with Master System	2206 - 028 - xxx

2206 - Swinghandle

Type of Cylinder		
	Double Bit 3 mm	2206 - 031 - xxx
	Double Bit 5 mm	2206 - 032 - xxx
	Triangular 8 mm	2206 - 037 - xxx
	Triangular 8 mm	2206 - 033 - xxx
	Triangular 9 mm	2206 - 039 - xxx
	Square 7 mm	2206 - 034 - xxx
	Square 8 mm	2206 - 035 - xxx
	Slotted	2206 - 038 - xxx

	Keyed 3333	2206 - 013 - xxx
	Keyed Same	2206 - 017 - xxx
	Keyed Differ	2206 - 019 - xxx
	Keyed Differ with Master System	2206 - 018 - xxx

You may chose XXX section from cam tables



Swinghandles

Material

Handle : Polyamide (PA6 GFR30), black
Dish : Polyamide (PA6 GFR30), black
Sliding Cover : Polyamide (PA6 GFR30), black

Options

Cams : Page 84-85
Round Rods : Page 81
Rod Guides : Page 82

Complete Plastic

IP 65



LH/RH



RoHS